

**HS-PHB**

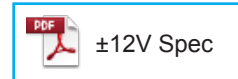

- Rated current 35A ~ 50A
- Realized high precision and compact size
- Superior in response, linearity and temperature characteristics
- For additional ±15V and ±12V products, contact sales@dgseals.com or click below

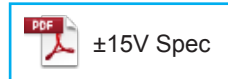

Applications

Inverters, Servo drivers, Power supply equipment, NC machine tools

**Dimensions**

(mm)

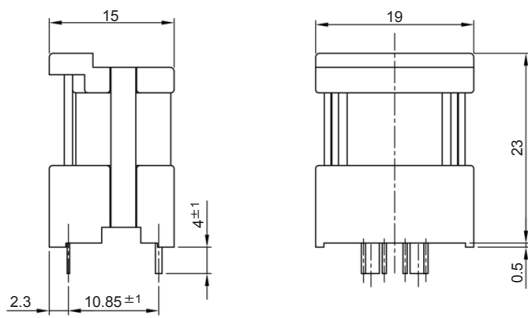

Dimensions of Current Input Terminals

Size of primary winding	Width D
Φ1.3	Φ1.3
□ 1.2 x 2	□ 1.2 x 2

- Terminal No. 1 - (-) terminal  
 2 - GND  
 3 - (+) terminal  
 4 - Output  
 5 - (+) input  
 6 - (-) input

Weight : 12g

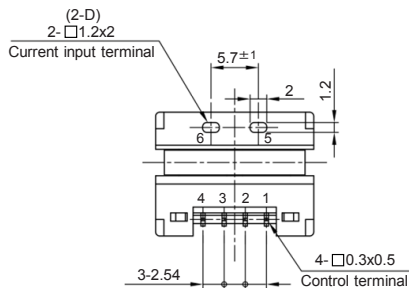

General tolerance: ±0.5

Specification

Ta=25°C

Type	Voltage output type		
	HS-PHB35V4B15	HS-PHB40V4B15	HS-PHB50V4B15
Rated current [ If ]	±35A	±40A	±50A
Continuously flowing DC current	±25.2A	±28.8A	±36A
Saturation current [ Is ]	±87.5A	±100A	±125A
Linearity limits	0~±70A	0~±80A	0~±100A
Size of primary winding	Φ1.3	□1.2 x 2	□1.2 x 2
Turns	1	1	1
Rated output [ Vh ]	±4V±1.5% (RL=10kΩ)		
Residual output [ Vo ]	Within ±30mV		
Output linearity	Within ±0.5%		
Response time	Within 3μs (at di/dt=If/μs)		
Response performance	Within 20%		
Hysteresis voltage range	Within 50mV		
Output Temp. Coef.	Within ±0.04%/°C		
Residual output Temp. Coef.	Within ±1mV/°C		
Control power supply	±15V±5%		
Consumption current	20mA+(Input current x N)/1270		
Operating Temp.	-10°C~+80°C		
Storage Temp.	-15°C~+85°C		
Dielectric withstand voltage	2500V AC 50/60Hz 1minute		
Insulation resistance	Not less than 500MΩ 500V DC		

Note1) The indicated residual output is the one after the core hysteresis is removed.

Note2) Energization time of saturation current shall be within 1 second.

Note3) Energization time of continuous live DC current x150% shall be within 1 minute.

Characteristics chart

HS-PHB35V4B15 (RL=10kΩ)

Time base: 5μs/div.

Pulse current response characteristic

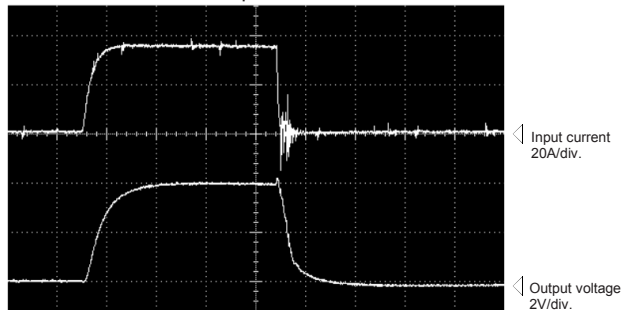

Noise characteristics (Effects of dv/dt)

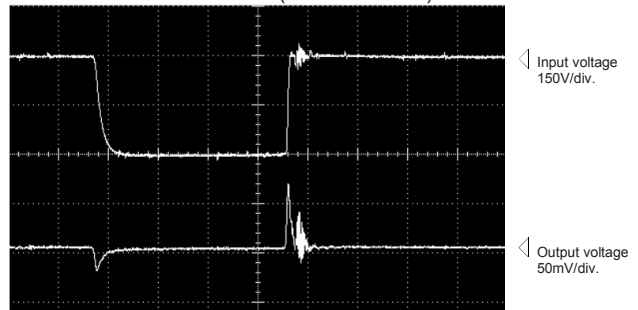

Noise characteristics (Effects of impulse noise)

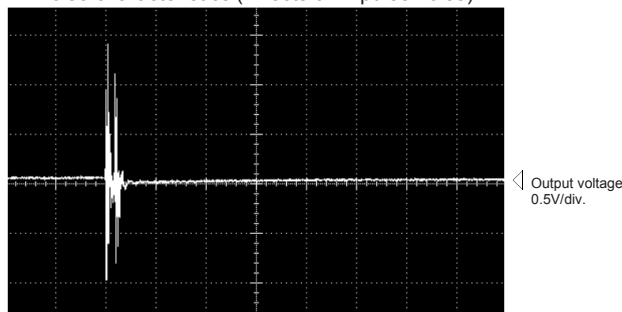

Input/output characteristics

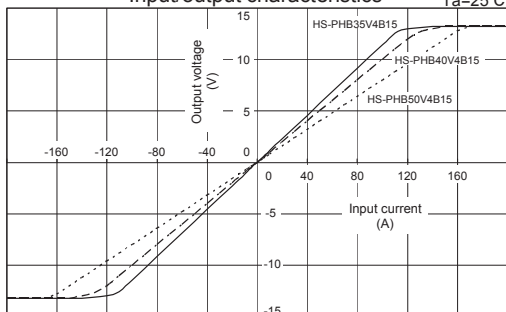

Note: The marks "◁" means 0V or 0A.