

**HC-ML**

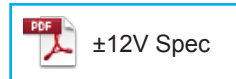

- Rated current 300A ~ 3000A
- Screw type control terminals also available
- For additional ±15V and ±12V products, contact sales@dgseals.com or click below

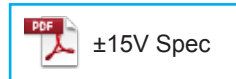

**Applications**

Inverters, Power supply equipment, Uninterruptible power supply (UPS), NC machine tools, Welders

**Dimensions**

(mm)

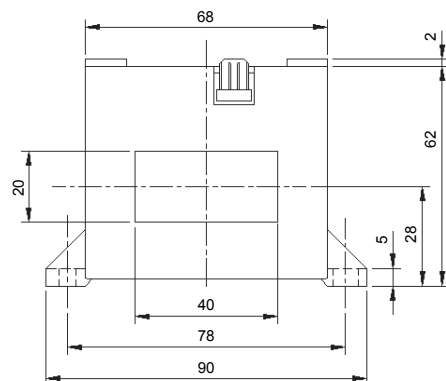
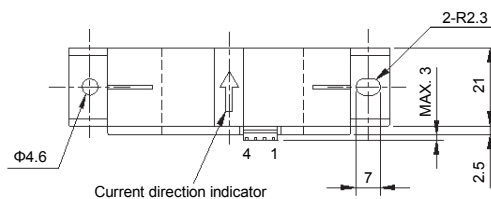

General tolerance: ±0.5

Supported connector housing  
 5051-04 (MOLEX)

- Terminal No.
- 1 - (+) terminal
  - 2 - (-) terminal
  - 3 - Output
  - 4 - GND

5046-04AG  
 (MOLEX)

Weight : 200g

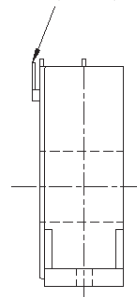

**Specification**

Ta=25°C

Type	HC-ML300V4B15	HC-ML600V4B15	HC-MLE10V4B15	HC-MLE15V4B15	HC-MLE30V4B15
Rated current [If]	±300A	±600A	±1000A	±1500A	±3000A
Saturation current [Is]	±900A	±1200A	±2400A	±2400A	±5000A
Linearity limits	0~±900A	0~±1000A	0~±2100A	0~±2100A	0~±4500A
Rated output [Vh]	±4V±1%				±4V±2%
Residual output [Vo]	Within ±30mV				
Output linearity	Within ±1%				
Response time	Within 10µs (at di/dt=100A/µs)				
Response performance	Within 10%				
Hysteresis voltage range	Within 30mV				
Output Temp. Coef.	Within ±0.1%/°C				
Residual output Temp. Coef.	Within ±1mV/°C				
Control power supply	±15V±5%				
Consumption current	Within 30mA	Within 50mA			
Operating Temp.	-10°C~+80°C				
Storage Temp.	-15°C~+85°C				
Dielectric withstand voltage	2500V AC 50/60Hz 1minute				
Insulation resistance	Not less than 500MΩ 500V DC				

Note1) The indicated rated output is the one when no load is applied.

Note2) The indicated residual voltage is the one after the core hysteresis is removed.

**Characteristics chart**

HC-MLE10V4B15

5µs/div. Time base

Pulse current response characteristic

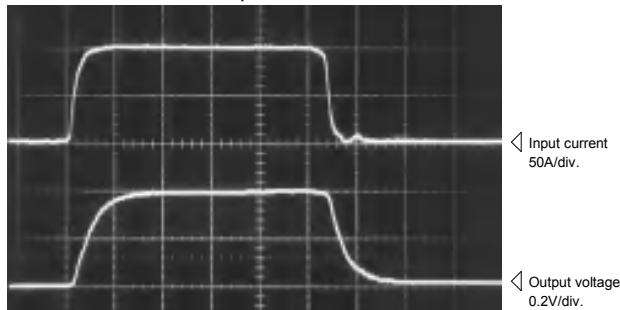

Noise characteristics (Effects of dv/dt)

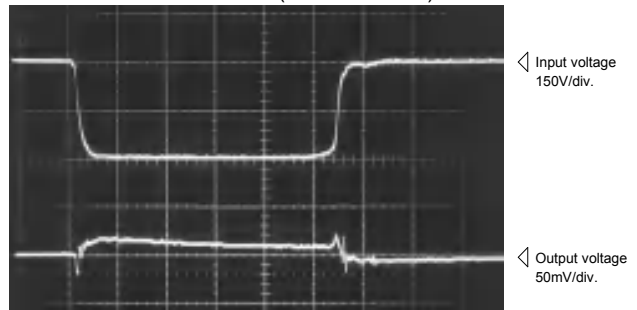

Noise characteristics (Effects of impulse noise)

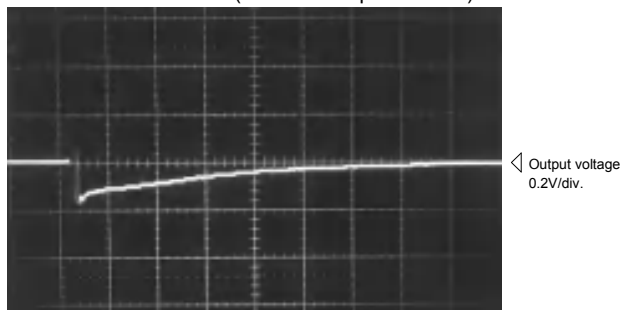

Input/output characteristics

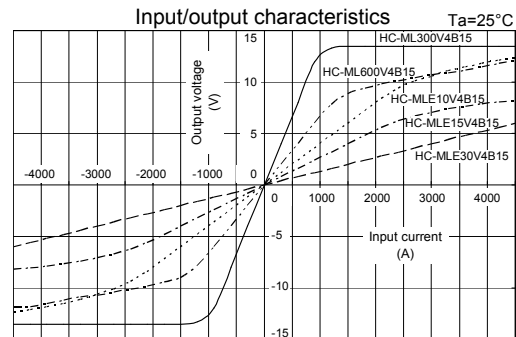

Note: The marks "◁" means 0V or 0A.